



11'x 11' Outdoor Hardtop Double Roof
Wood Framed Gazebo



**ASSEMBLY AND OPERATING
INSTRUCTIONS**

Recommended number

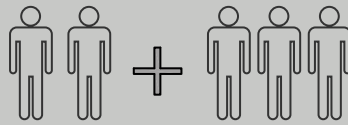

Needed for assembly

(The following tools are not included)

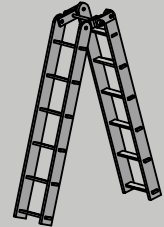
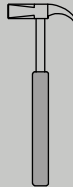
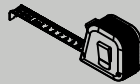
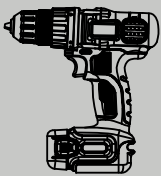











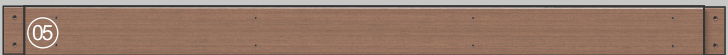

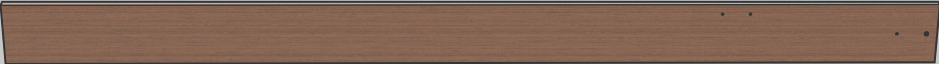

Installation Tips

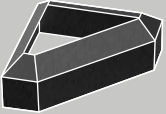



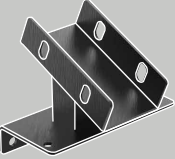

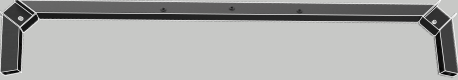

(Do not fully tighten the screws)

1. When assembling **Step 7**, please do not fully tighten the EE/AA of E, until one side of wood post and beams are completely assembled(Step 8).
2. When assembling **Step 10**, the EE/AA of E and D need to be loosened a bit, then tighten them once finishing assemble H2.
3. When assembling **Step 14**, please do not fully tighten the II and HH, until all the top support parts (K-2, I-3) are completely assembled with the wood.
4. When assembling **Step 22**, please do not fully tighten the OO/HH of M and N, until each L7 and L8 are connected. Then tighten BB.

Parts List

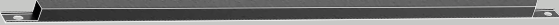
Part#		Qty
01		X4
02		X4
05		X4
06		X4
07		X4
08		X4
10		X4
11		X4
I-3		X4
I-4		X4
B		X4
C		X4
D		X4
E		X4
F		X4
G		X4
X2		X1

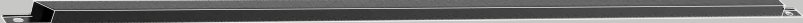
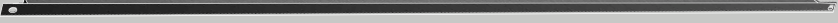
Parts List

Part#		Qty
U		X2
V2		X2
L2		X4
L2-1		X4
K-2		X4
L3-1		X4
L3-2		X4
L4-1		X4
L4-2		X4
L7		X4
L8		X4

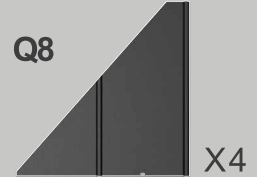
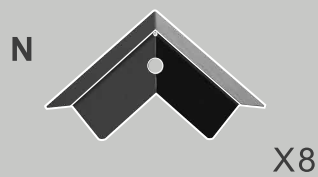
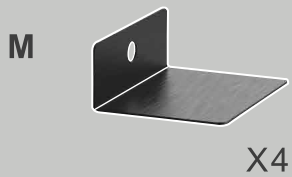













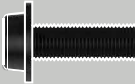

















Parts List



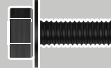

Part#

Q10		X4	Q1		X4
Q2		X4	Q3		X4
Q5		X4	Q6		X4
Q7		X4	R2		X1
S1				X12	
S2				X8	
T				X1	
H2				X8	



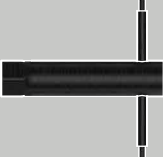

Parts List

Part#				Qty
AA	M10x135			8
BB	M5x30			48+2
CC	M8x25			24+1
DD	M5x40			56+2
EE	M10x70			8
FF	M8x35			16+1
GG	M8x35			16+1
HH	M6x16			108+3
II	M6x55			16+1
JJ	M10			8
KK	M6			17+1
LL	M8			16+1
MM	M6			17+1
NN	M8			Preassemble
OO	M6x20			8
PP	Ø8			12
Z1	Ø3			2

Parts List

Part#			Qty
Z2	M6		2
Z3	M8		1
Z4	M10		2
Z5	M10		1
Z6			1

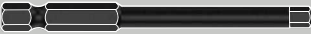
Complimentary Parts

ZA			1
ZB			1
ZC			1
ZD			1
ZE			1

Step 1

08 X4



B X4

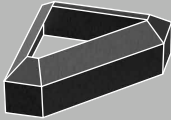

C X4

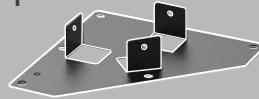

BB X12

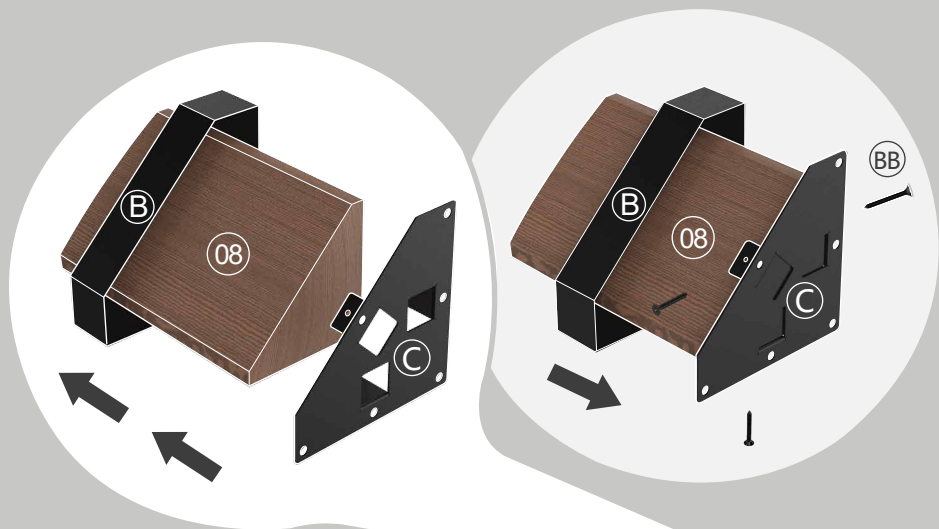

Step 2

01
X4



02
X4



D
X4



CC
X8



D's base is facing down.

NN



02

D

01

Step 3

05
X2



06
X4



CC
X8

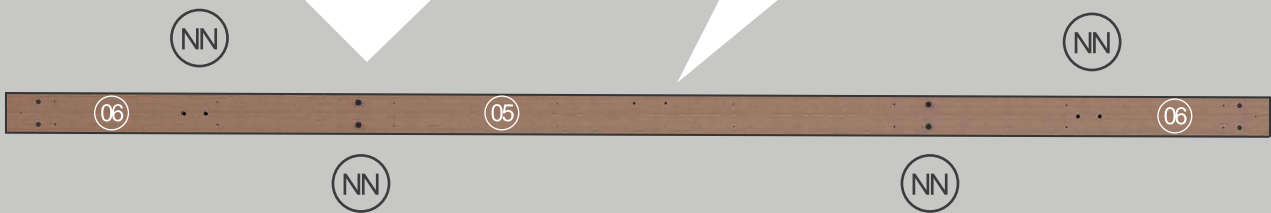
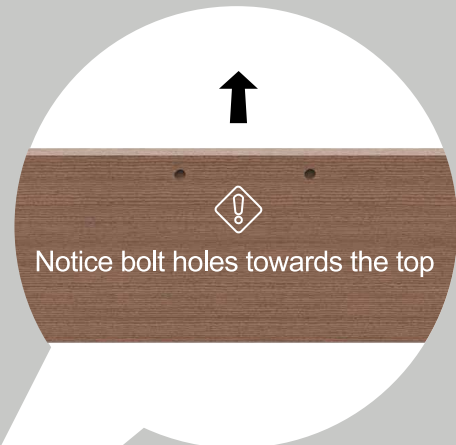
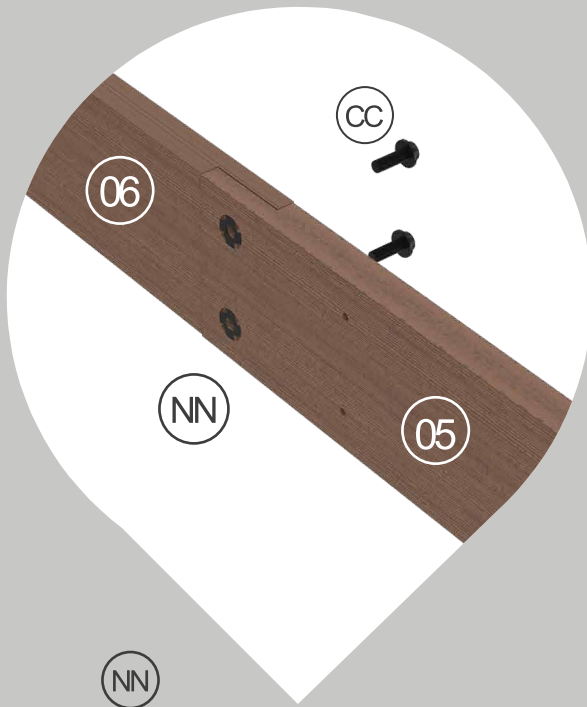

Step 4

Assemble the components installed in step 2 and Step 3, as shown in the following figure.

DD X28

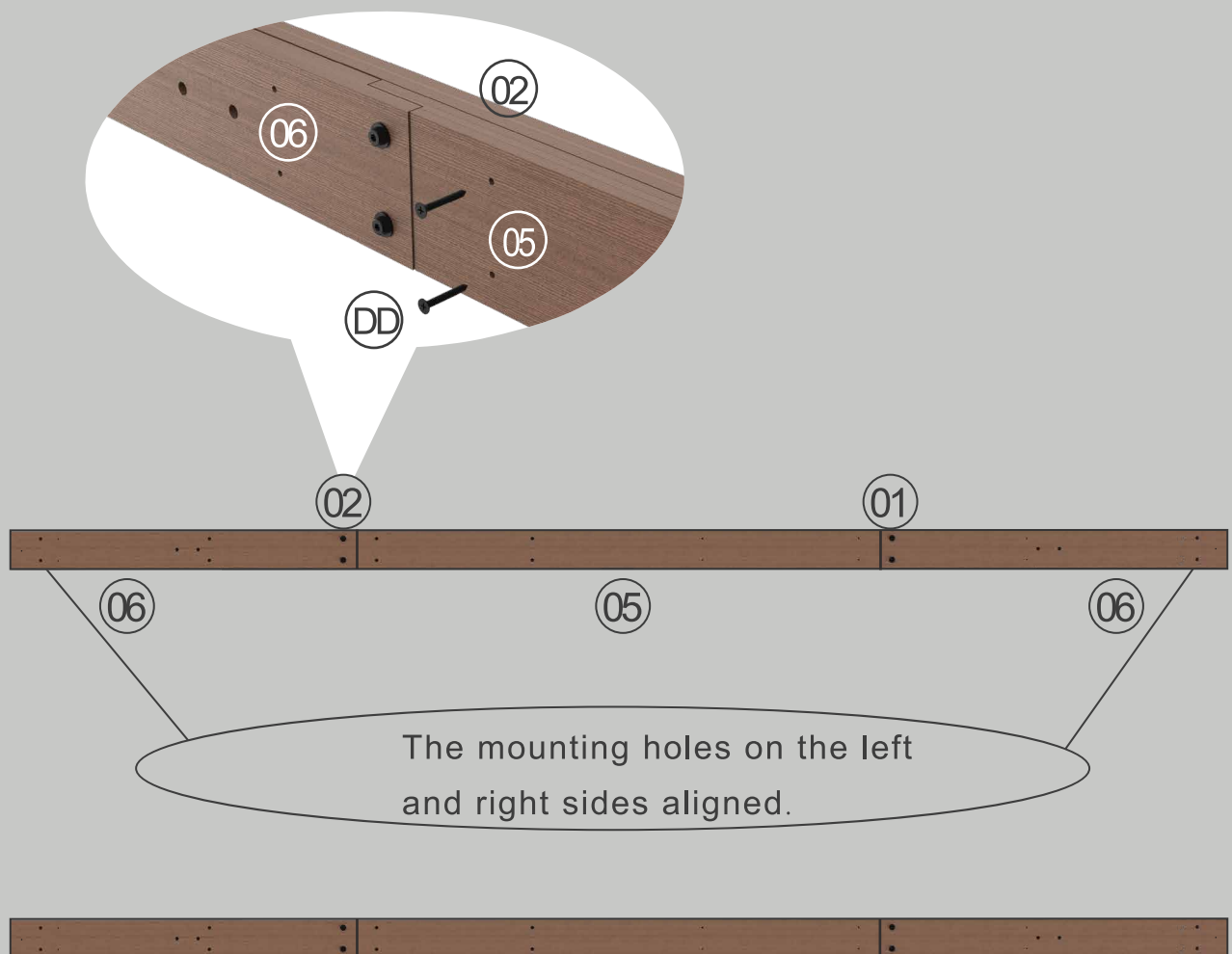
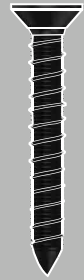

Step 5

05
X2



07
X4



CC
X8

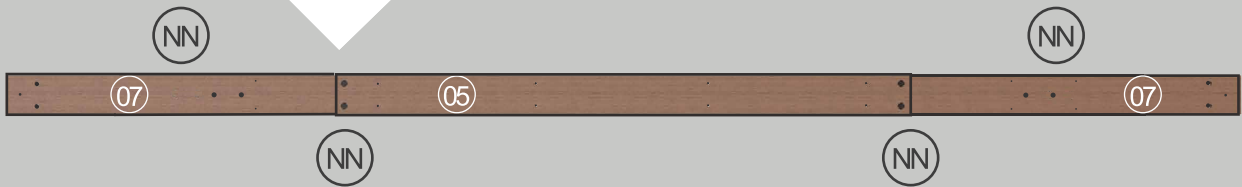
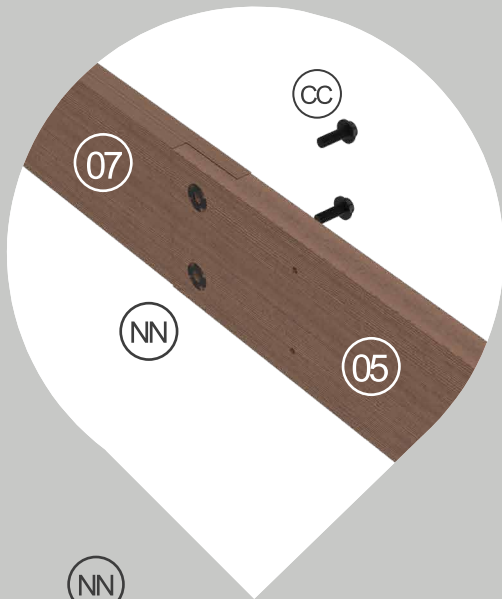
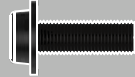

Step 6

Assemble the components installed in step 2 and Step 5, as shown in the following figure.

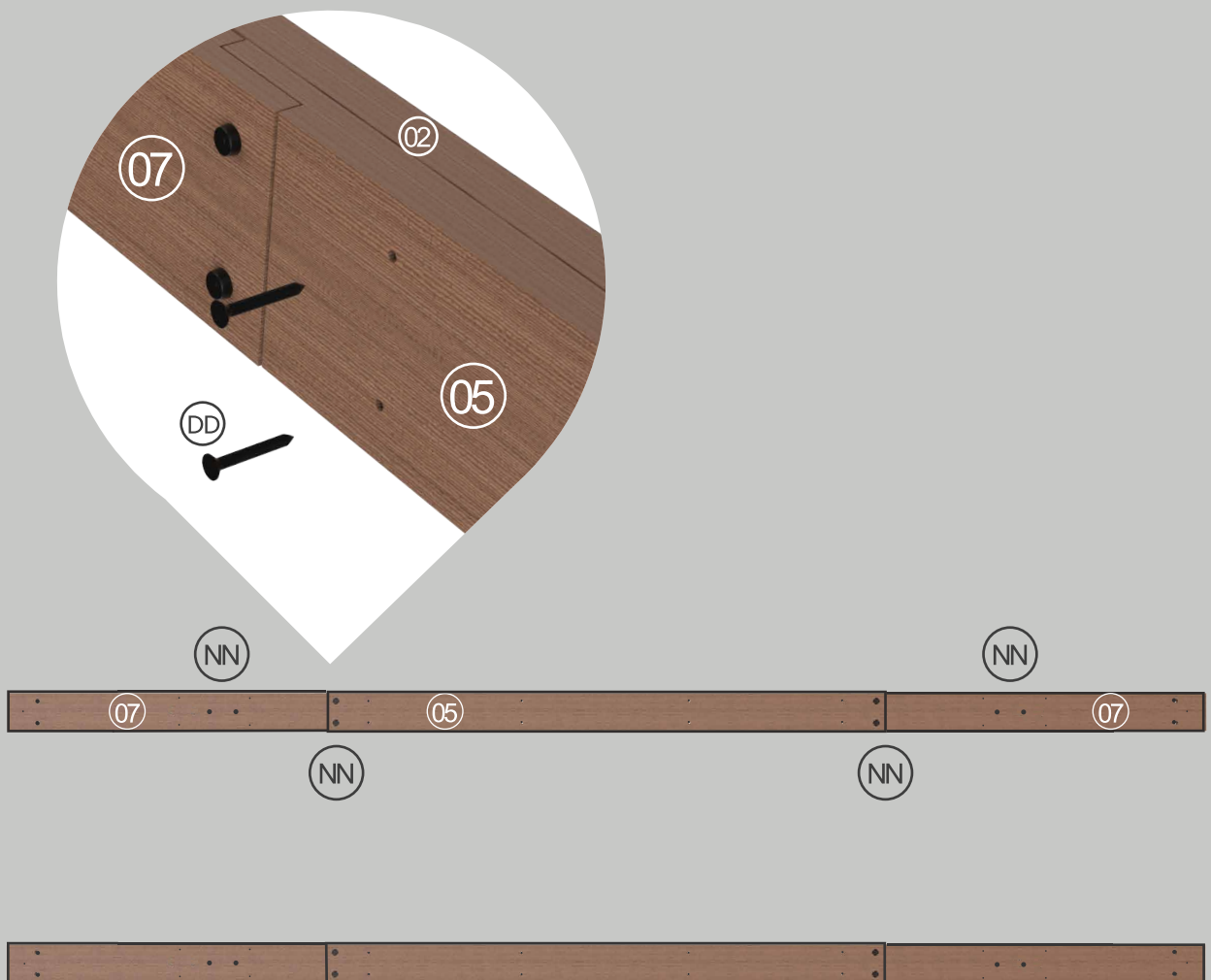
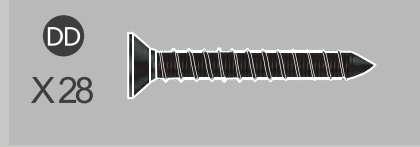

Step 7

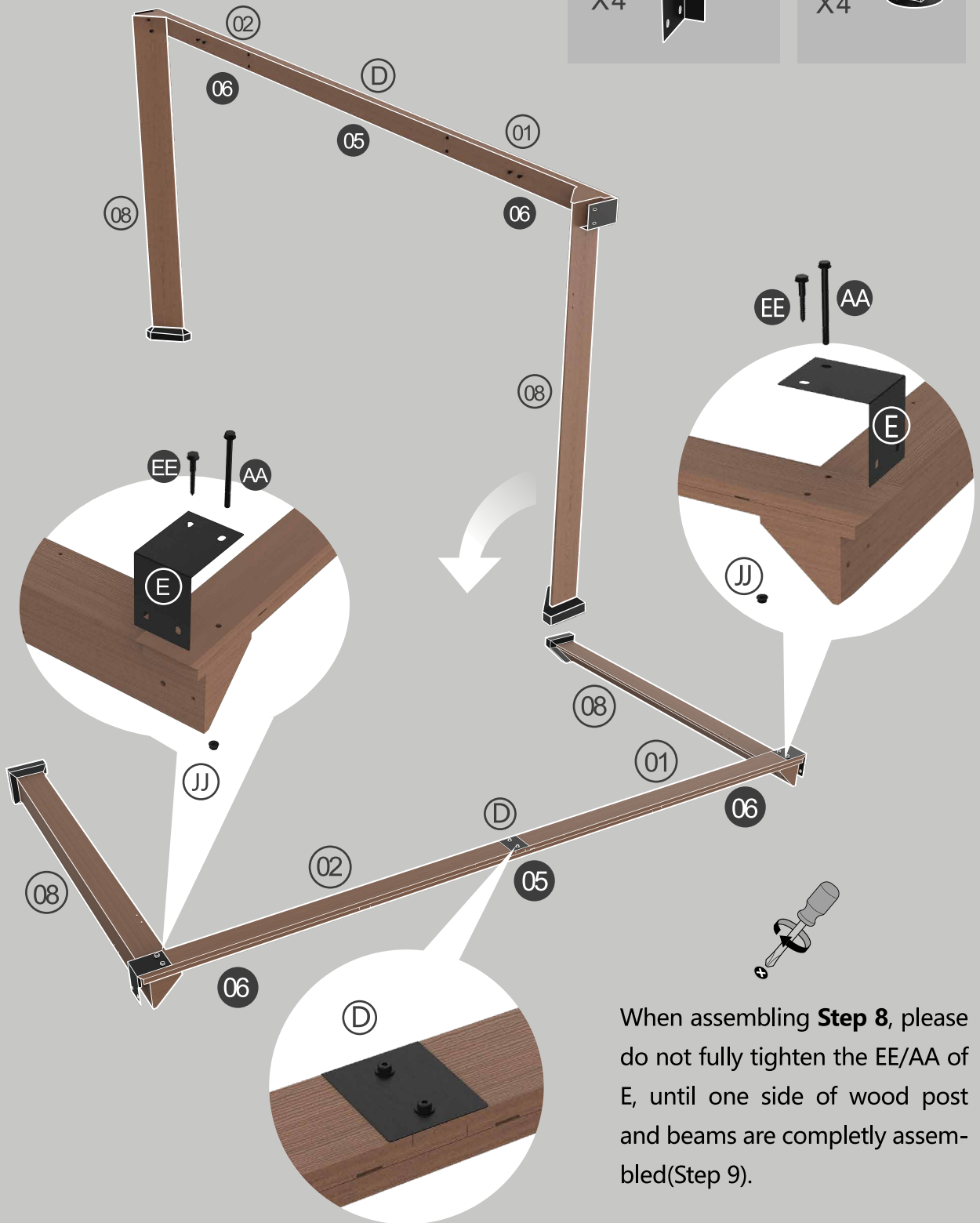
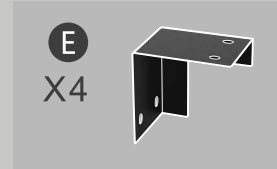
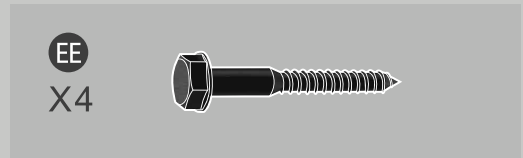

When assembling **Step 8**, please do not fully tighten the EE/AA of E, until one side of wood post and beams are completely assembled(Step 9).

Step 8

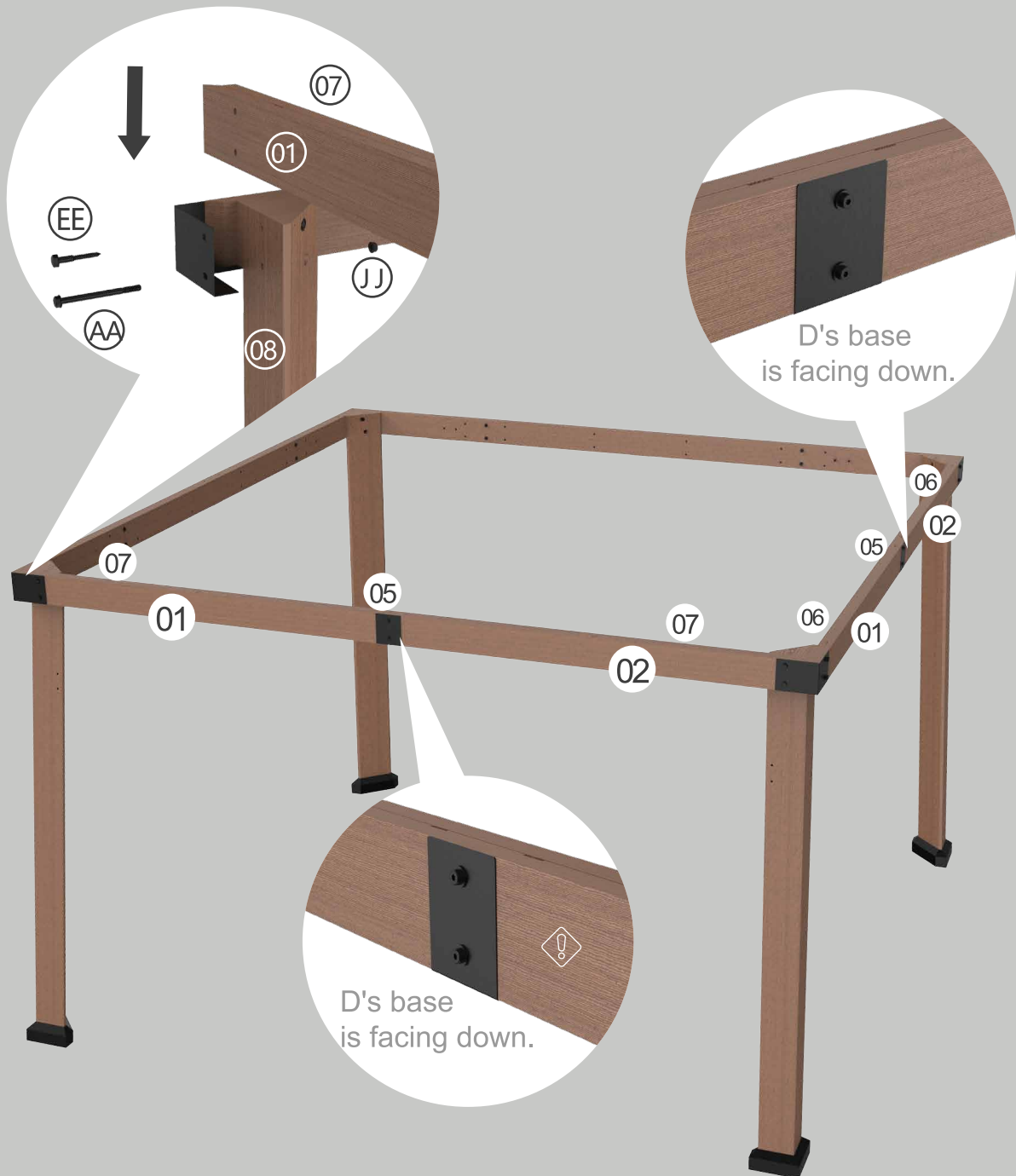
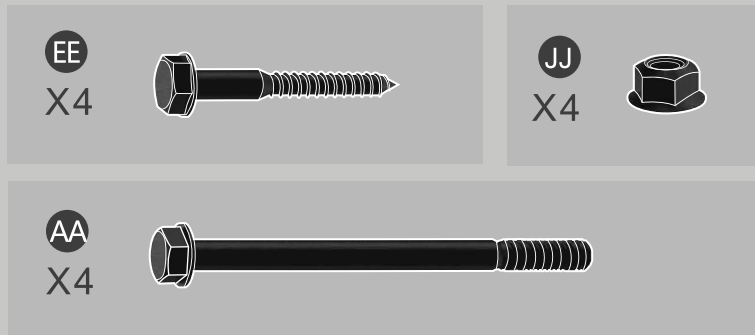

Step 9

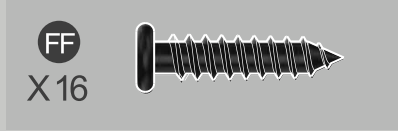
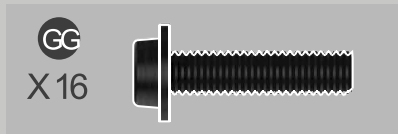
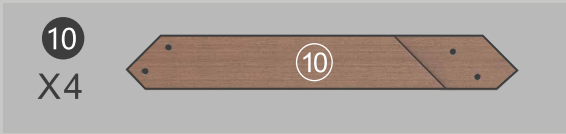

⚠ d1 = d2

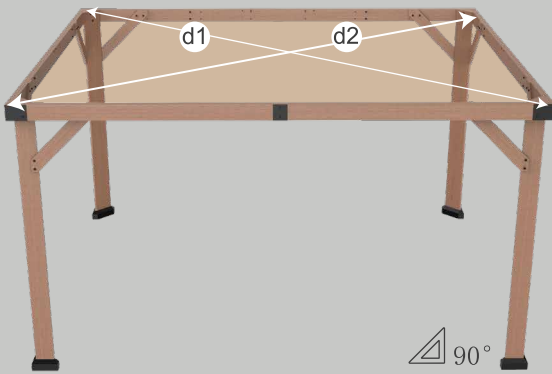

Tips:

Please measure to make sure **the length of d1 is equal to d2** before moving to next step to ensure a square frame and best results. Keep the beam at right angles to the post, the post at right angles to the ground, and keep the beam horizontal.

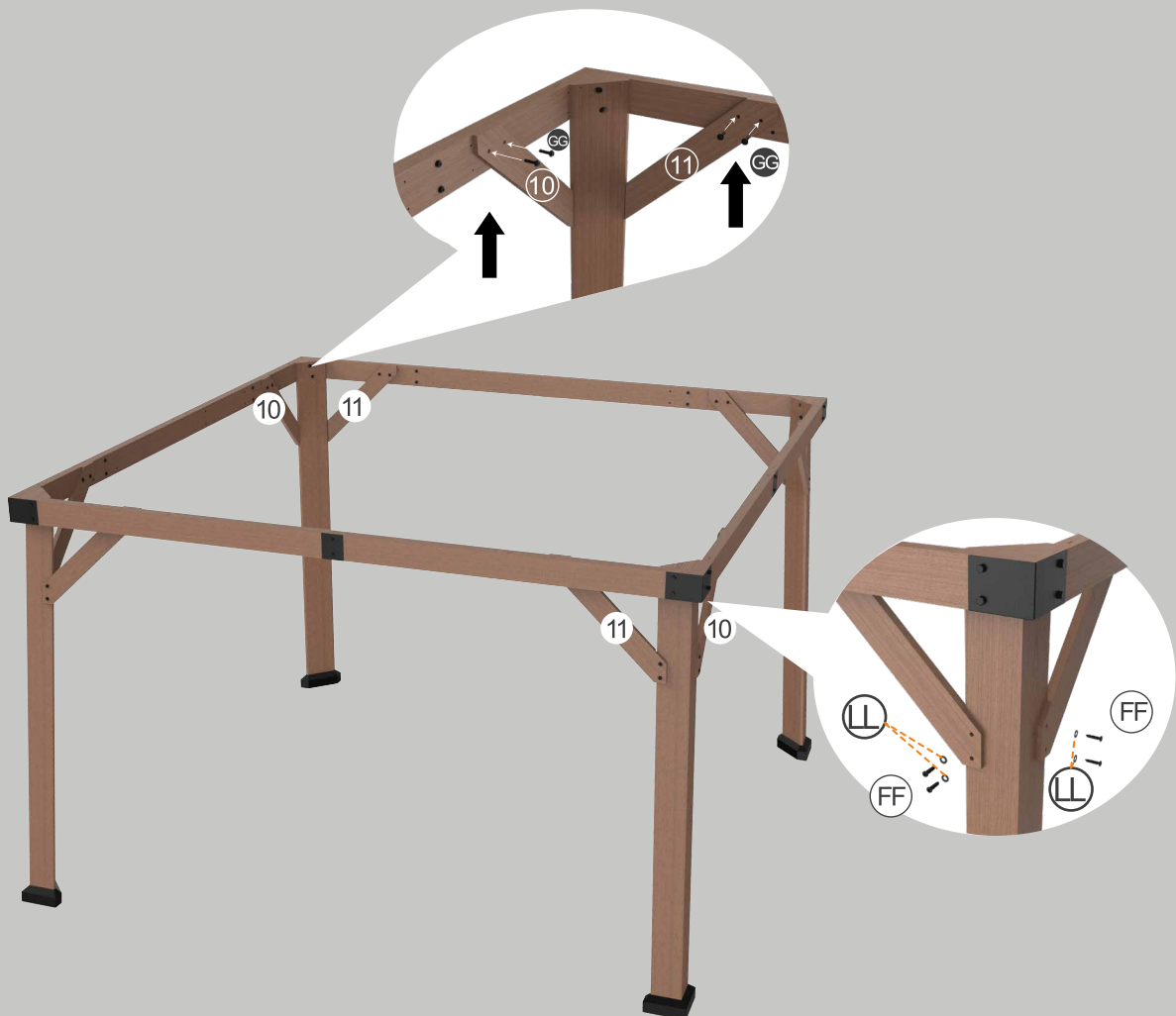

Step 10

H2
X8

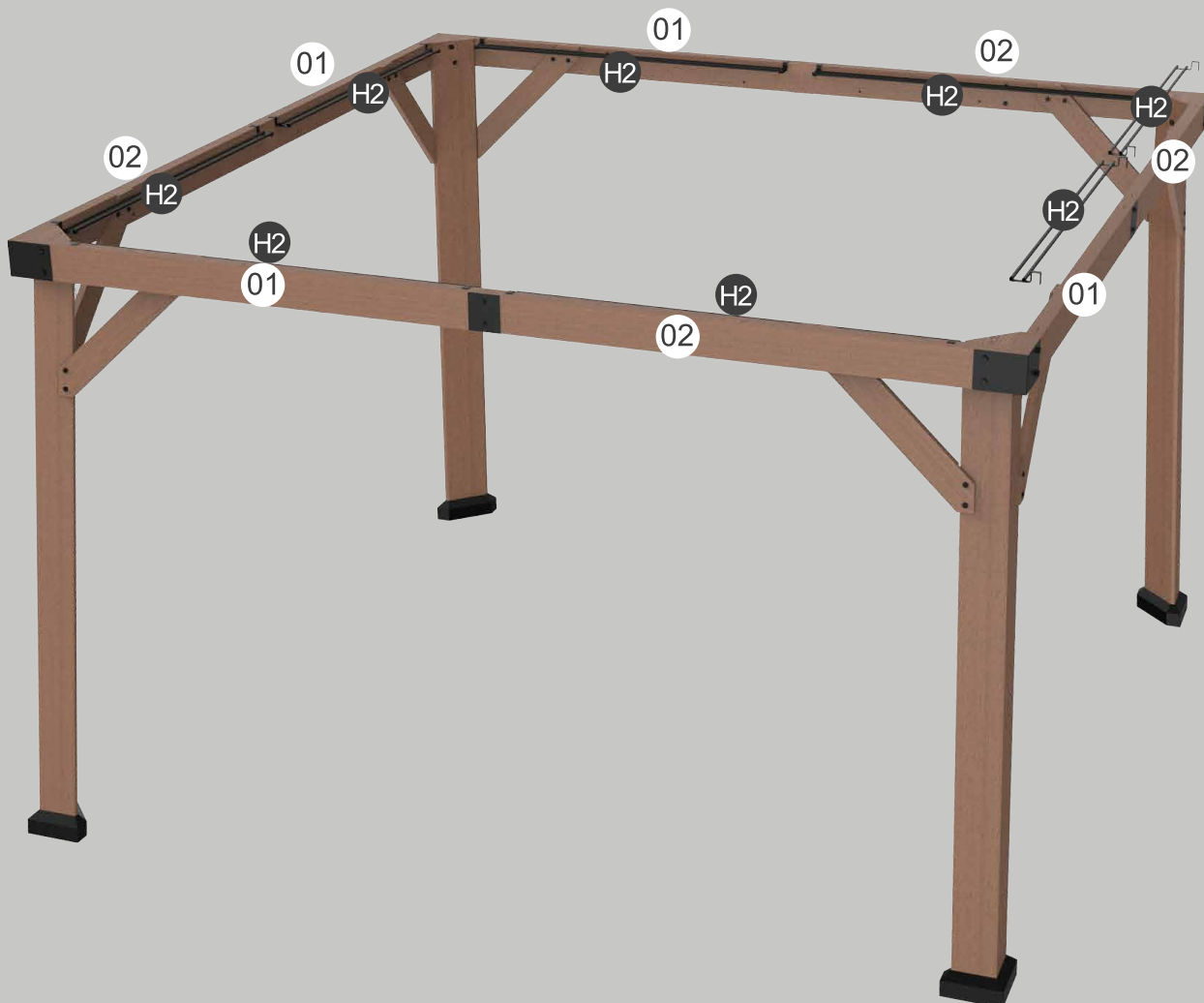
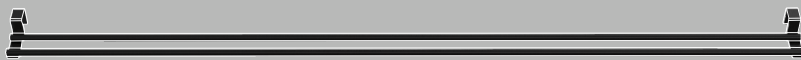

When assembling **Step 10**, the EE/AA of E and D need to be loosened a bit, then tighten them once finishing assemble H2.

Step 11

F
X4

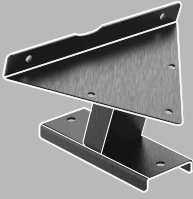

BB
X20

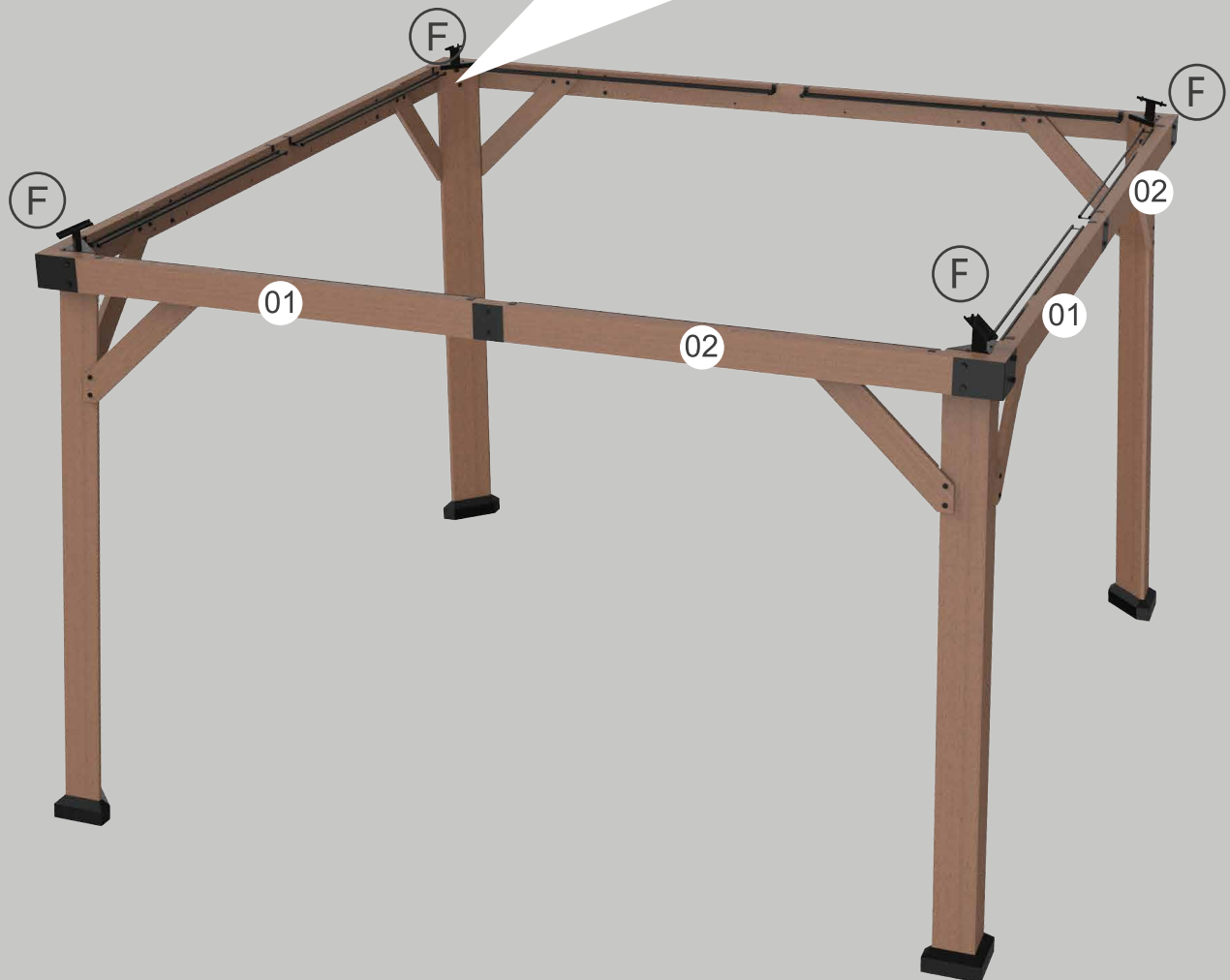
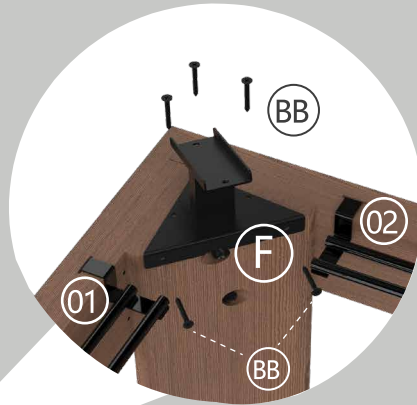

Step 12

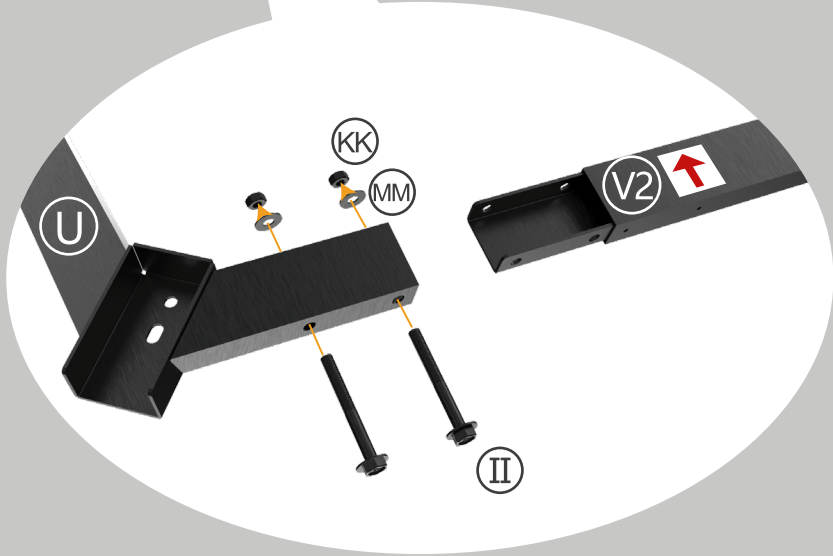
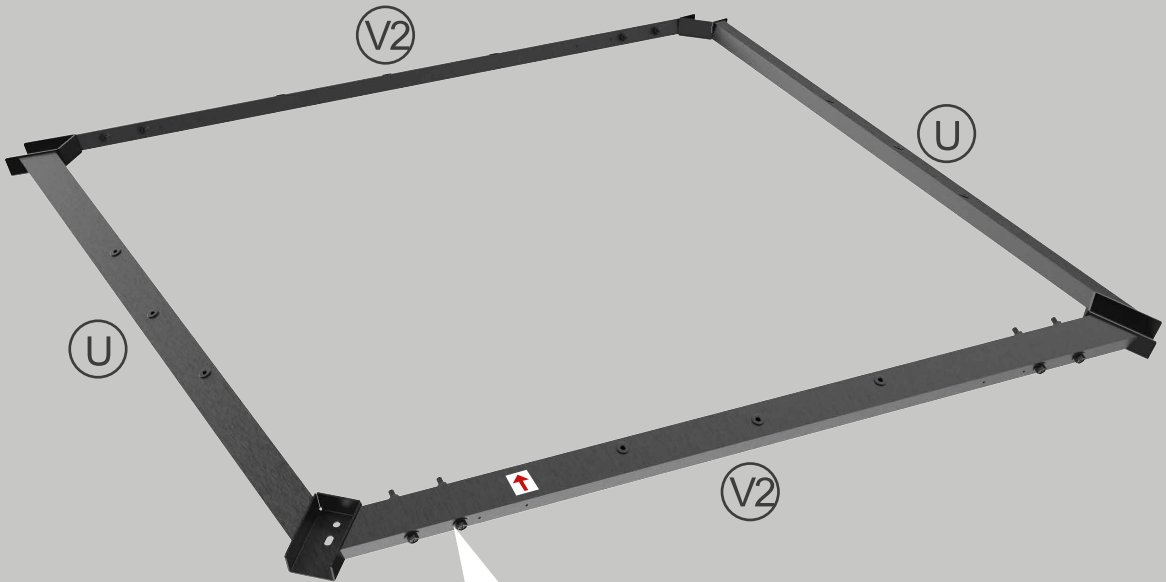
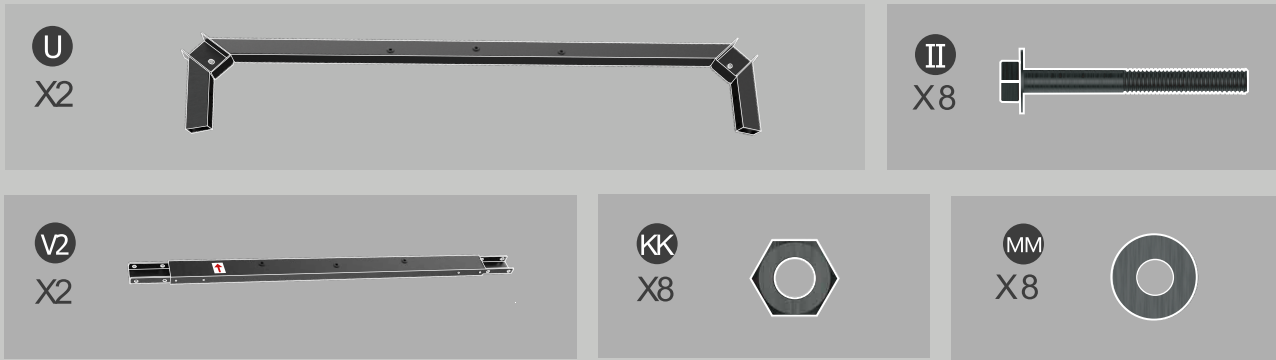

Step 13

I-3

X4



HH

X 16

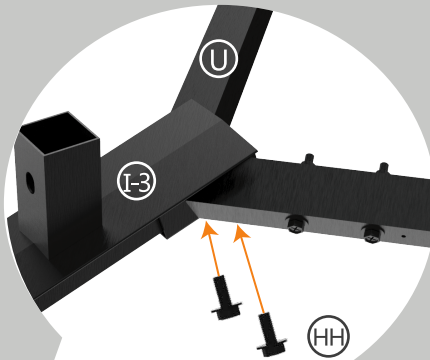

Step 14



When assembling **Step 14**, please do not fully tighten the II and HH, until all the top support parts (K-2, I-3) are completely assembled with the wood.

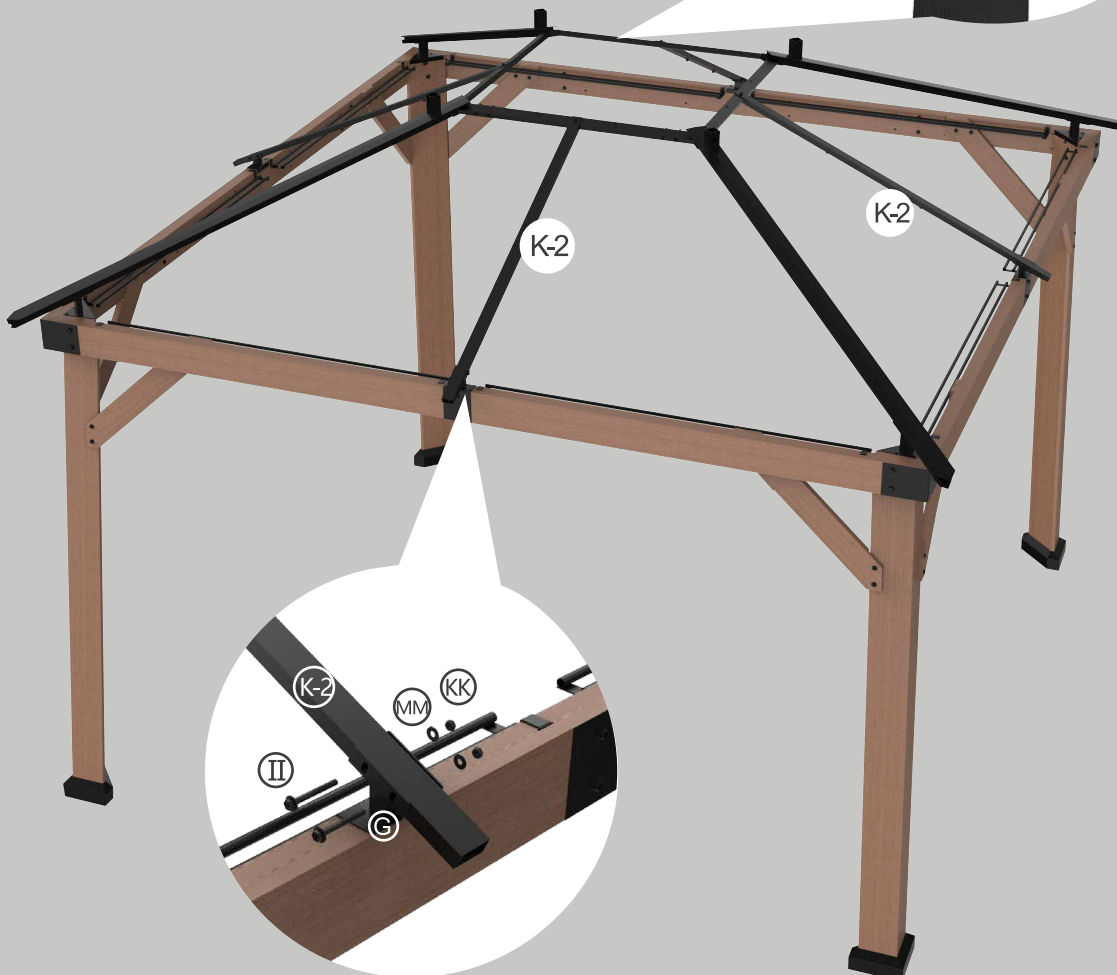

Step 15

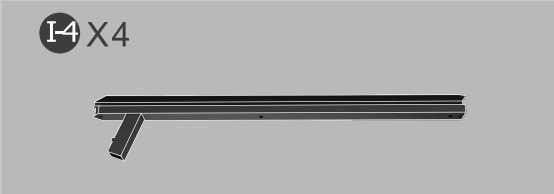
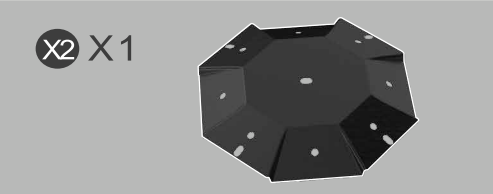

Step 16

L2 X4



HH X4

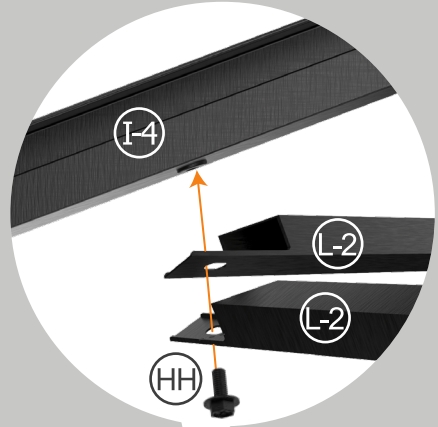

Step 17

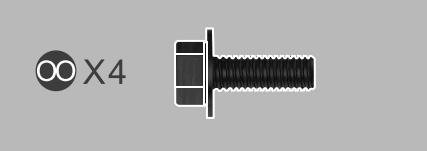
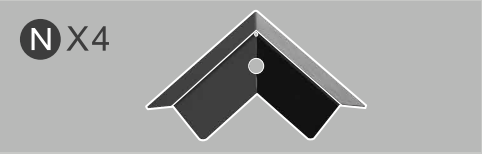
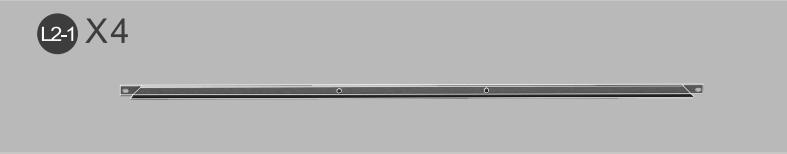

Step 18

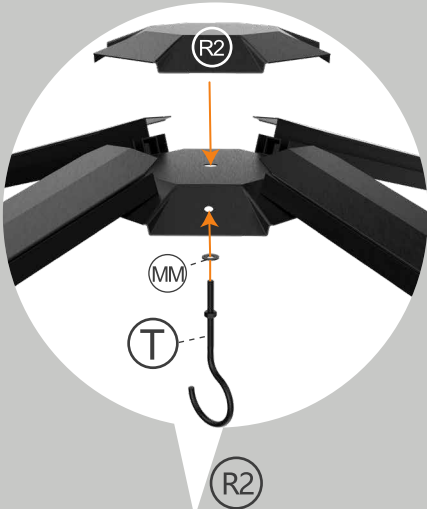
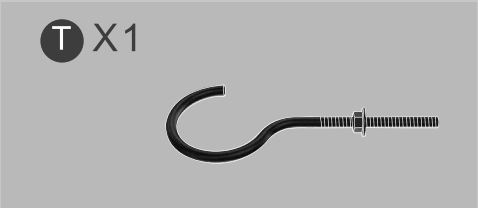
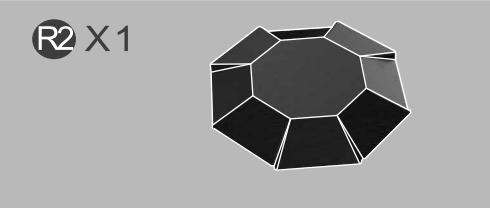

Step 19

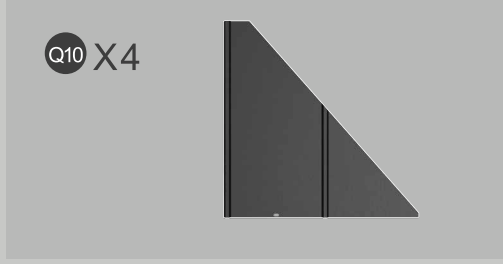
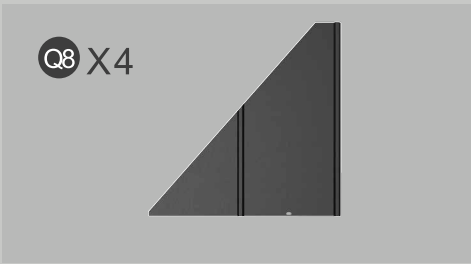

Step 20

S1 X4

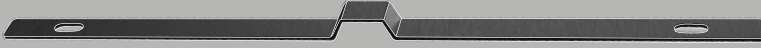

HH

X8



Step 21

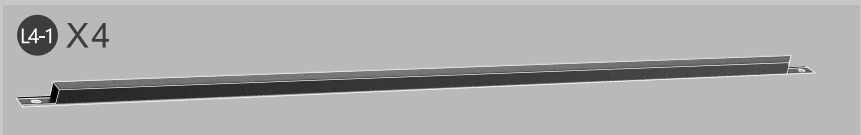
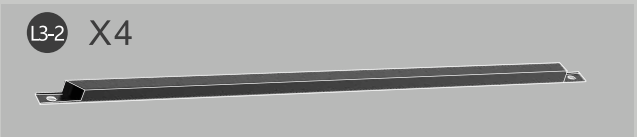

Step 22

L7 X4



M X4

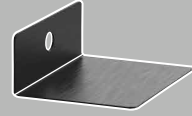

L8 X4



N X4



BB X16



OO X4

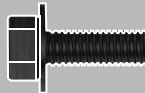

HH X4

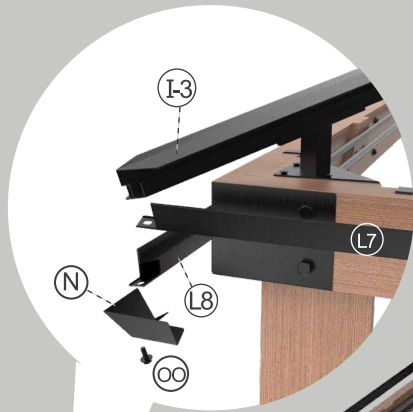
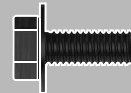

When assembling **Step 22**, please do not fully tighten the OO/HH of M and N, until each L7 and L8 are connected. Then tighten BB.



Step 23

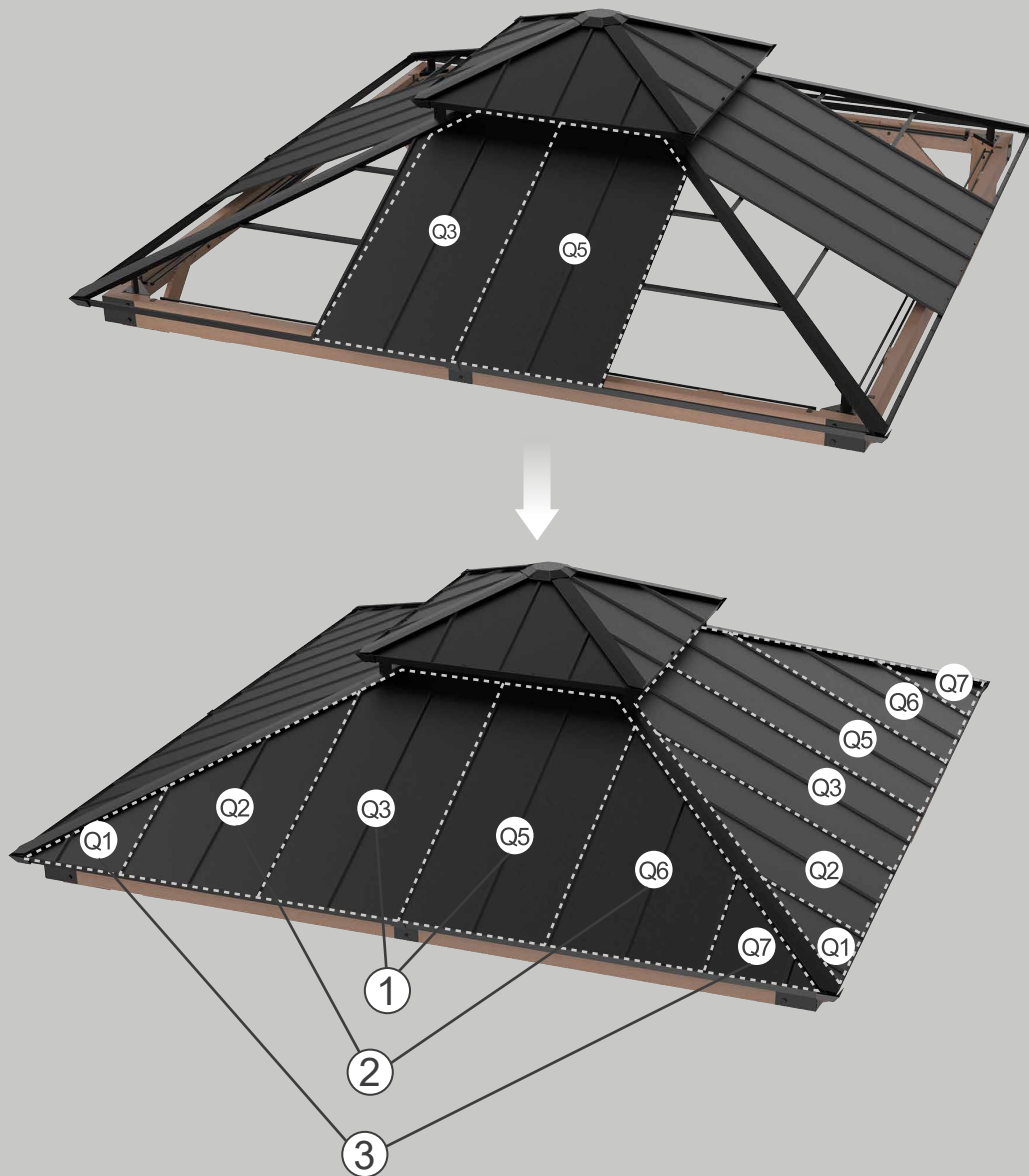
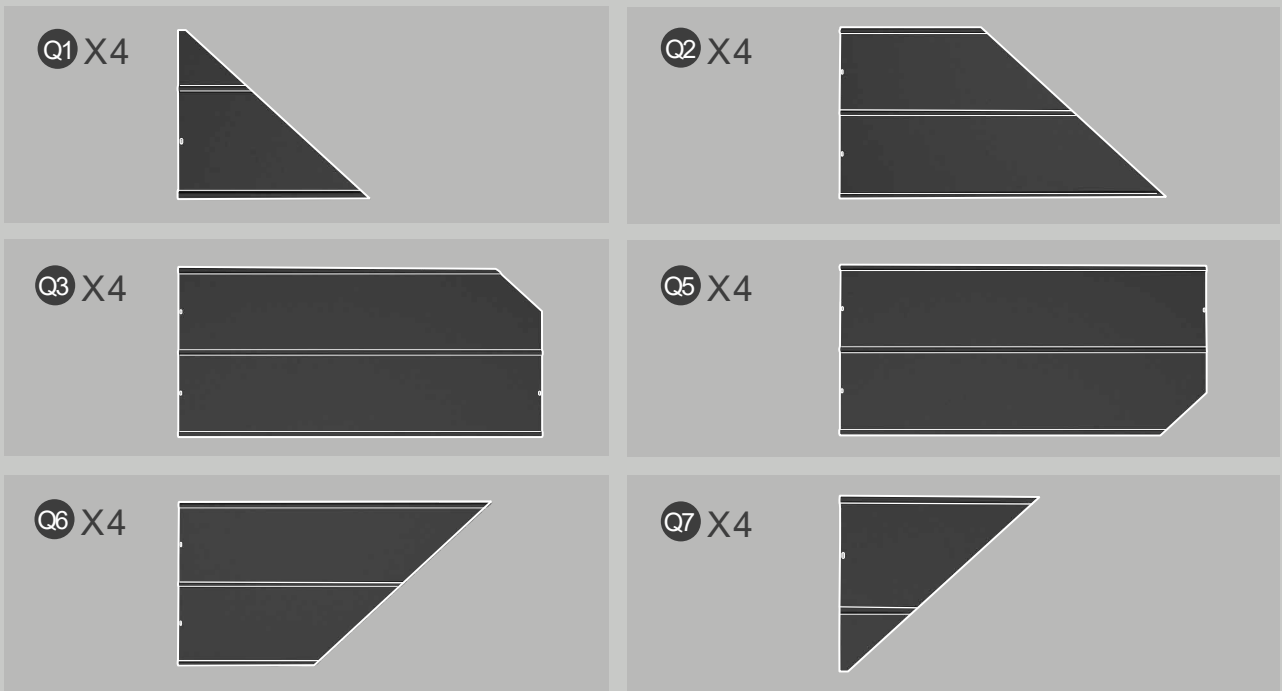

Step 24

S2 X8



S1 X8



HH

X48

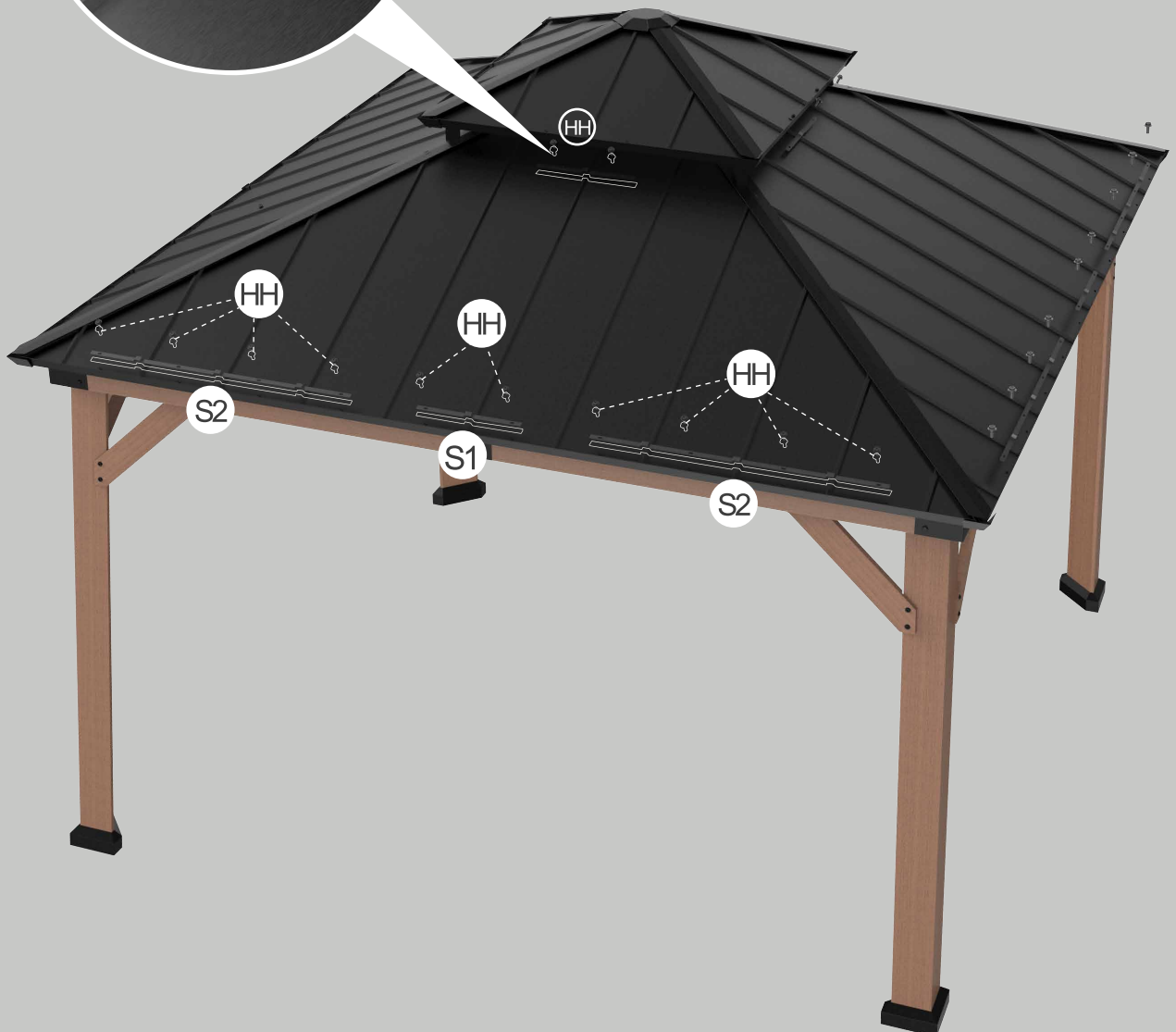
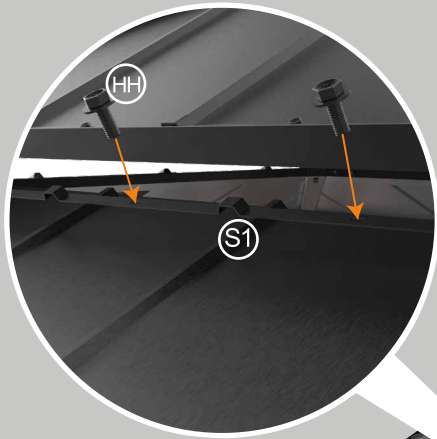

Step 25

PP X 12

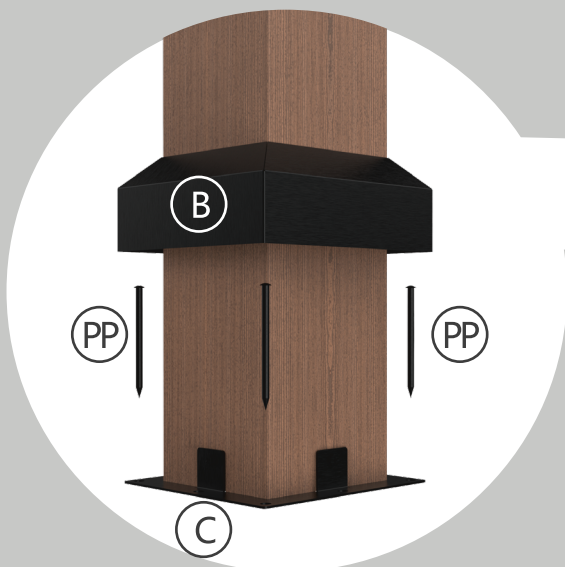

Tips:

Please purchase the anchors from local hardware store if anchor the gazebo to concrete or wood.

11'x 11' Outdoor Hardtop Double Roof
Wood Framed Gazebo





OUTDOOR GAZEBO



Always be creative.



Scan The Code To Obtain The Electronic Manual